

Installation instructions for PZ4AL-03807-00, PZ4AL-03808-00
Under Run Protective Shield Engine Bay and Transmission Case

TOYOTA RAV4



Model year:

RAV4 - 2019

Applicability:

MXAA54L-RNXXBX MXAA52L-RNXXBX AXAA54L-RNZMBX
MXAA54L-RNXMBX MXAA52L-RNXMBX AXAA54L-RNZGBX
MXAA54L-RNXGBX MXAA52L-RNFXGBX
MXAA54L-RNFMBX MXAA52L-RNFXBX

Part Number:

Steel: PZ4AL-03807-00
Aluminium: PZ4AL-03808-00
Installation kit: PZ4AL-03807-60



Weight:

Steel: 12,10 kg
Aluminium: 8,75 kg



Installation Time:

30 min

PZ4AL-03807-00, PZ4AL-03808-00

A

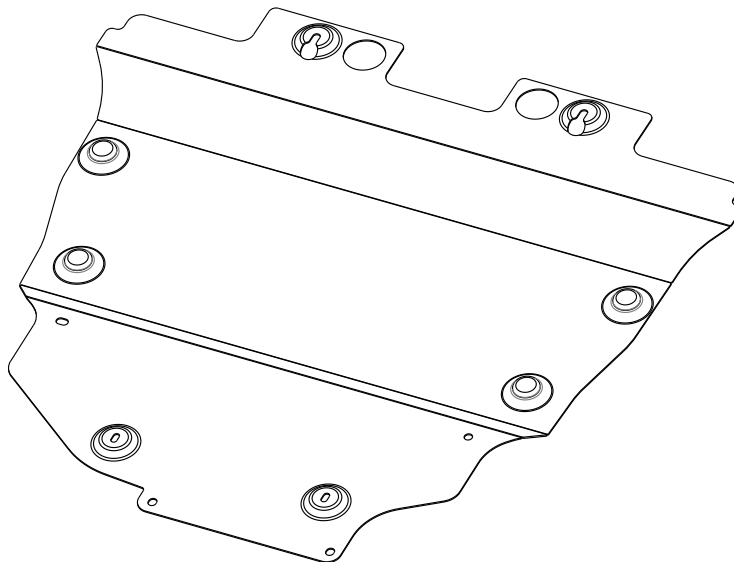

B

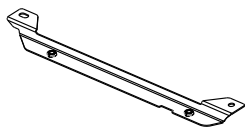

1x

1x

PZ4AL-03807-60

C

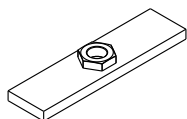

2x

D

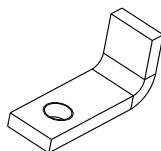

НД 16004

2x

E

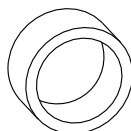

h=10

2x

F1

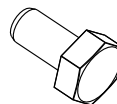

M8x16

2x

F2

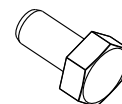

M8x30

2x

F3

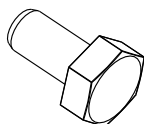

M10x40

2x

F4

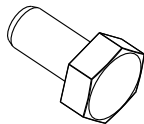

M10x90

2x

G

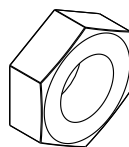

M10x1,25

2x

H

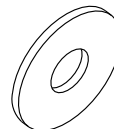

d=8

4x

I

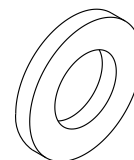

d=10

4x

J1

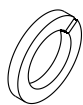

d=8

4x

J2

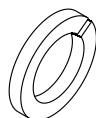

d=10

4x

K

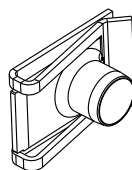

2x

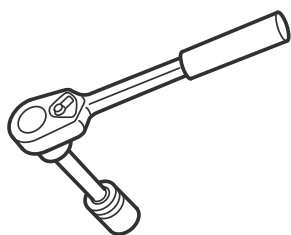

13 mm
17 mm

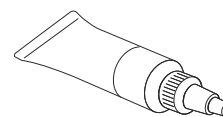

1

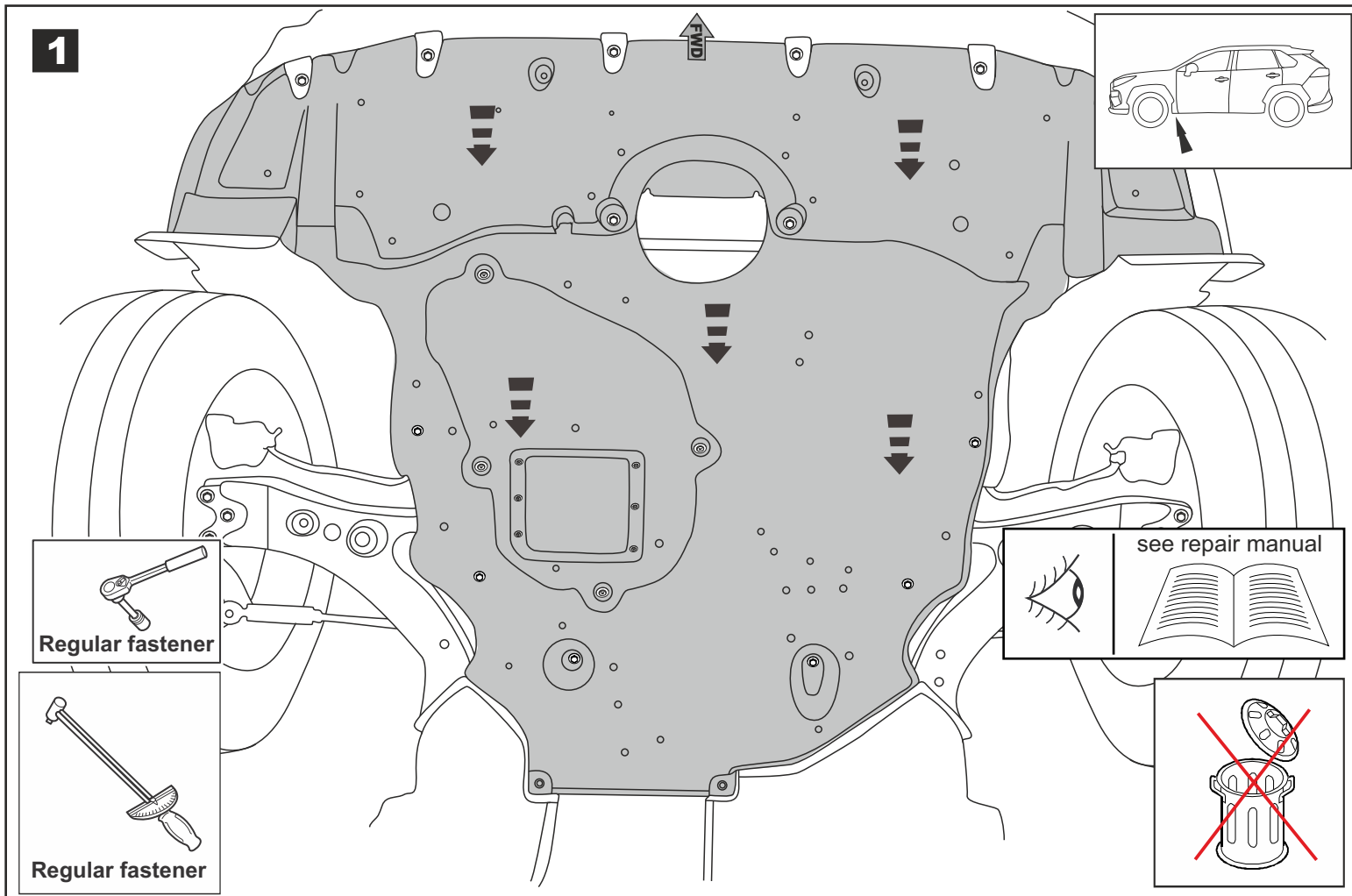

2

